

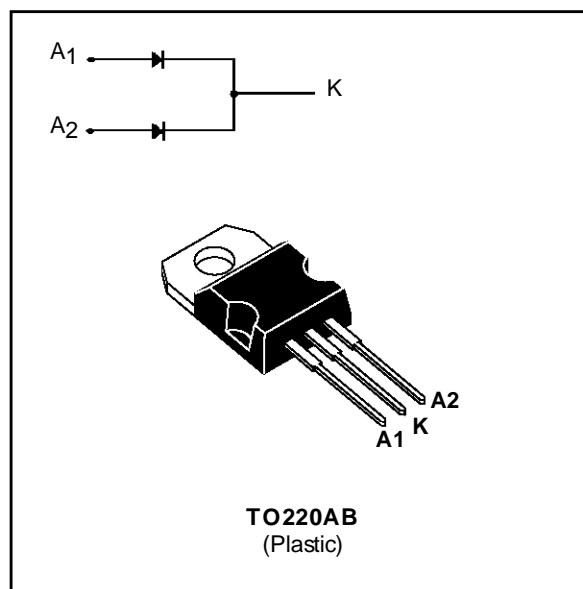
## ULTRA FAST RECOVERY RECTIFIER DIODES

- SUITED FOR SMPS
- LOW LOSSES
- LOW FORWARD AND REVERSE RECOVERY TIME
- HIGH SURGE CURRENT CAPABILITY
- HIGH AVALANCHE ENERGY CAPABILITY

### DESCRIPTION

Low cost dual center tap rectifier suited for switch-mode power supply and high frequency DC to DC converters.

Packaged in TO220AB, this device is intended for use in low voltage, high frequency inverters, free wheeling and polarity protection applications.



### ABSOLUTE RATINGS (limiting values)

Symbol	Parameter		Value	Unit
I <sub>F(RMS)</sub>	RMS Forward Current	Per diode	20	A
I <sub>F(AV)</sub>	Average Forward Current	T <sub>c</sub> = 120°C δ = 0.5 Per diode Per device	8 16	A
I <sub>FSM</sub>	Surge Non Repetitive Forward Current	T <sub>p</sub> = 10 ms Sinusoidal Per diode	80	A
T <sub>stg</sub> T <sub>J</sub>	Storage and Junction Temperature Range		- 65 to + 150 - 65 to + 150	°C

Symbol	Parameter	STPR		Unit
		1610CT	1620CT	
V <sub>RRM</sub>	Repetitive Peak Reverse Voltage	100	200	V

### THERMAL RESISTANCE

Symbol	Parameter		Value	Unit
R <sub>th(j-c)</sub>	Junction-case	Per diode total	3.0	°C/W
R <sub>th(c)</sub>	Coupling			°C/W

When the diodes 1 and 2 are used simultaneously :  
 $\Delta T_{j(\text{diode } 1)} = P(\text{diode } 1) \times R_{th(\text{Per diode})} + P(\text{diode } 2) \times R_{th(c)}$

## STPR1610CT/STPR1620CT

### ELECTRICAL CHARACTERISTICS

#### STATIC CHARACTERISTICS

Symbol	Tests Conditions		Min.	Typ.	Max.	Unit
$I_R^*$	$T_j = 25^\circ\text{C}$	$V_R = V_{RRM}$			50	$\mu\text{A}$
	$T_j = 100^\circ\text{C}$				0.6	mA
$V_F^{**}$	$T_j = 125^\circ\text{C}$	$I_F = 8\text{ A}$			0.99	V
	$T_j = 125^\circ\text{C}$	$I_F = 16\text{ A}$			1.20	
	$T_j = 25^\circ\text{C}$	$I_F = 16\text{ A}$			1.25	

Pulse test : \*  $t_p = 5\text{ ms}$ , duty cycle  $< 2\%$

\*\*  $t_p = 380\text{ }\mu\text{s}$ , duty cycle  $< 2\%$

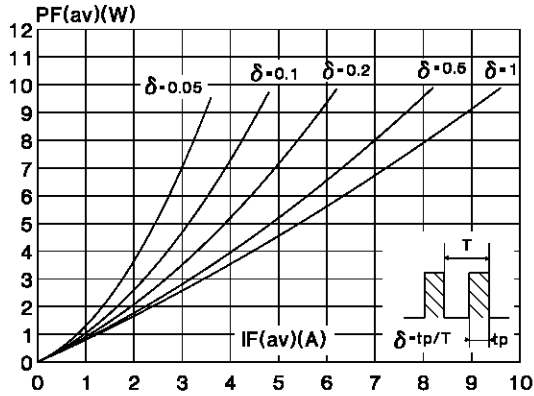
#### RECOVERY CHARACTERISTICS

Symbol	Tests Conditions			Min.	Typ.	Max.	Unit
$t_{rr}$	$T_j = 25^\circ\text{C}$	$I_F = 0.5\text{ A}$	$I_R = 1\text{ A}$ $I_{rr} = 0.25\text{ A}$			30	ns
$t_{fr}$	$T_j = 25^\circ\text{C}$	$I_F = 1\text{ A}$	$t_r = 10\text{ ns}$ $V_{FR} = 1.1 \times V_F$		20		ns
$V_{FP}$	$T_j = 25^\circ\text{C}$	$I_F = 1\text{ A}$	$t_r = 10\text{ ns}$		3		V

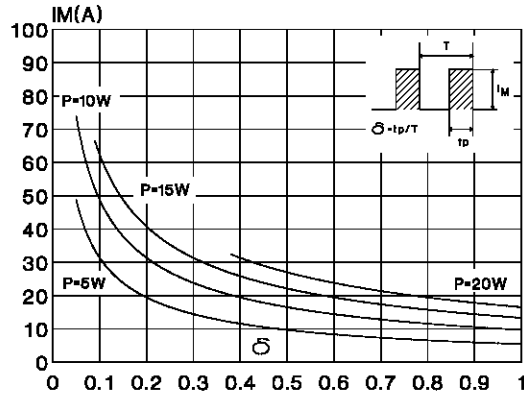
To evaluate the conduction losses use the following equation :

$$P = 0.78 \times I_F(AV) + 0.026 I_F^2(RMS)$$

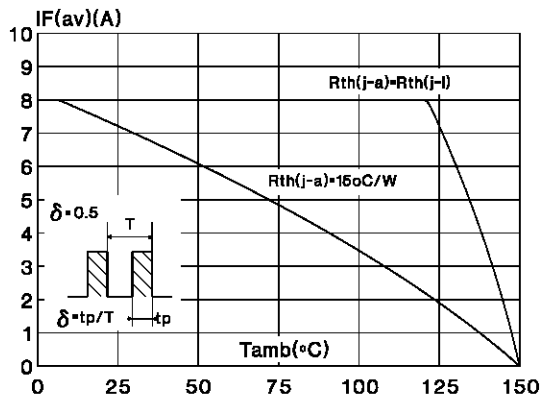
**Fig.1 :** Average forward power dissipation versus average forward current. (Per diode)



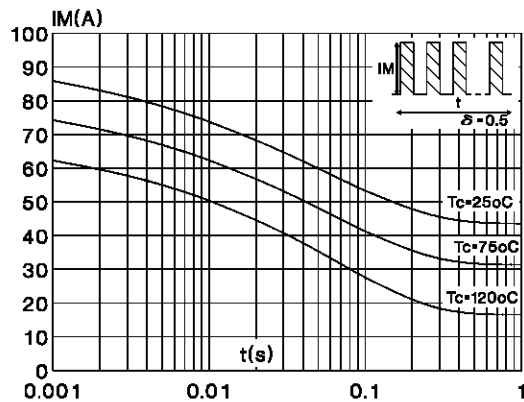
**Fig.2 :** Peak current versus form factor. (Per diode)



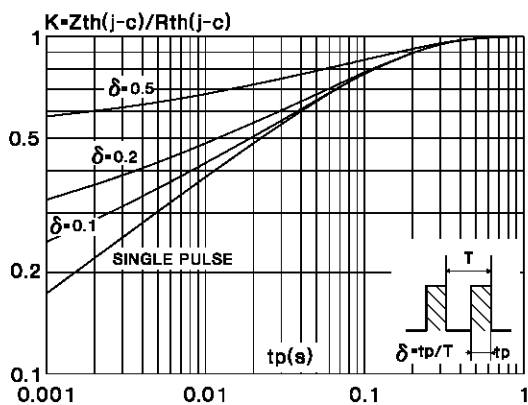
**Fig.3 :** Average current versus ambient temperature. (duty cycle : 0.5) (Per diode)



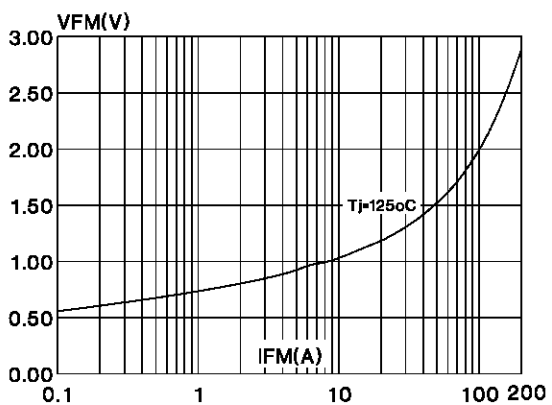
**Fig.4 :** Non repetitive surge peak forward current versus overload duration. (Maximum values)



**Fig.5 :** Relative variation of thermal transient impedance junction to case versus pulse duration. (Per diode)

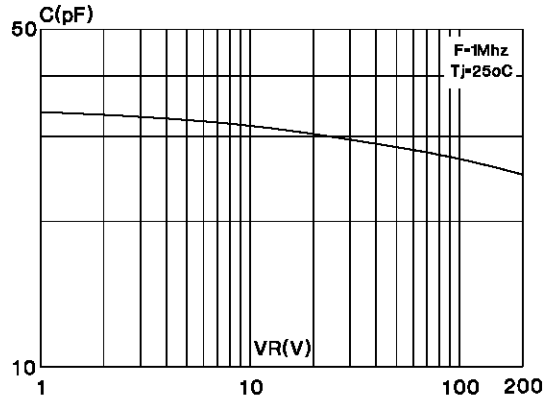


**Fig.6 :** Forward voltage drop versus forward current. (Maximum values) (Per diode)

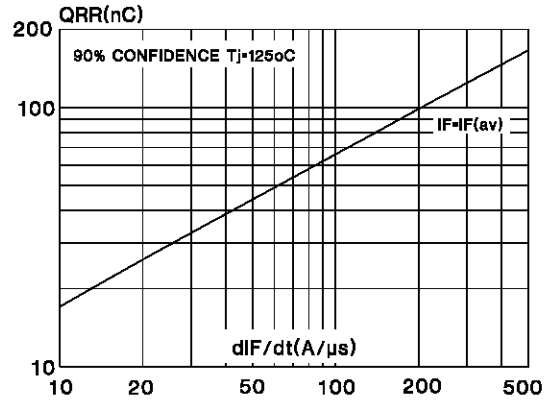


# STPR1610CT/STPR1620CT

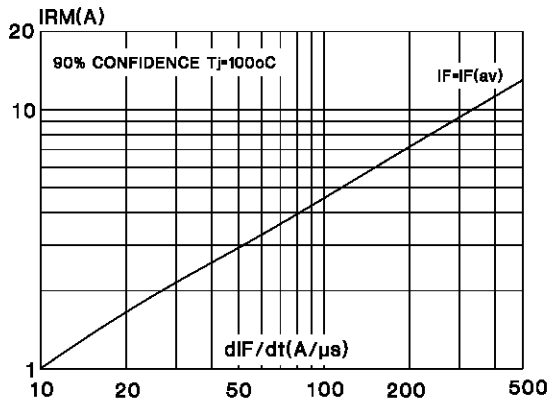
**Fig.7 :** Junction capacitance versus reverse voltage applied. (Typical values) (Per diode)



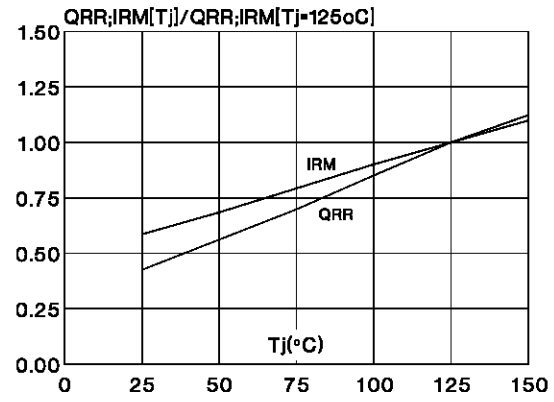
**Fig.8 :** Recovery charge versus  $dI/dt$ . (Per diode)



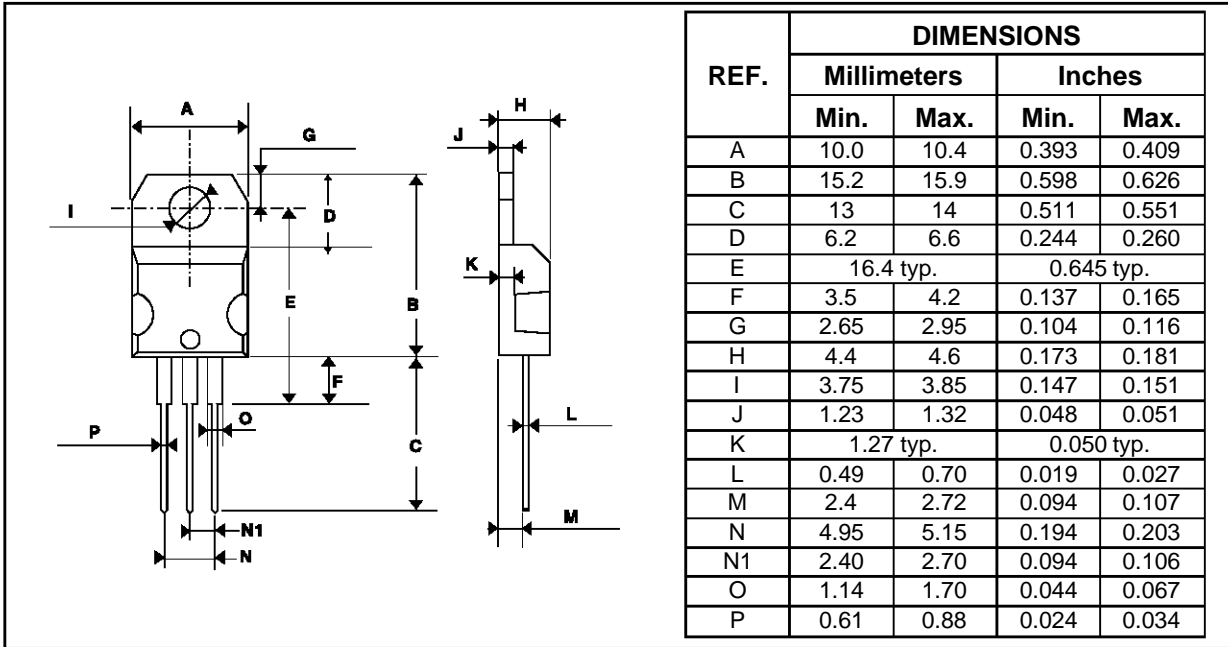
**Fig.9 :** Peak reverse current versus  $dI/dt$ . (Per diode)



**Fig.10 :** Dynamic parameters versus junction temperature. (Per diode)



**PACKAGE MECHANICAL DATA**  
TO220AB (JEDEC outline)



Cooling method : C  
 Marking : Type number  
 Weight : 2 g  
 Recommended torque value : 0.55m.N  
 Maximum torque value : 0.7m.N

Information furnished is believed to be accurate and reliable. However, SGS-THOMSON Microelectronics assumes no responsibility for the consequences of use of such information nor for any infringement of patents or other rights of third parties which may result from its use. No license is granted by implication or otherwise under any patent or patent rights of SGS-THOMSON Microelectronics. Specifications mentioned in this publication are subject to change without notice. This publication supersedes and replaces all information previously supplied. SGS-THOMSON Microelectronics products are not authorized for use as critical components in life support devices or systems without express written approval of SGS-THOMSON Microelectronics.

© 1994 SGS-THOMSON Microelectronics - All Rights Reserved

TURBOSWITCH, TRANSIL, TRISIL, SNUBBERLESS are Trademarks of SGS-THOMSON Microelectronics.

SGS-THOMSON Microelectronics GROUP OF COMPANIES

Australia - Brazil - France - Germany - Hong Kong - Italy - Japan - Korea - Malaysia - Malta - Morocco - The Netherlands -  
Singapore - Spain - Sweden - Switzerland - Taiwan - Thailand - United Kingdom - U.S.A